

Synchrotron

Synchrotron

- Ativação Cúbica 3D (Cube Activation 3D)
- Hipercubo (Hypercube)

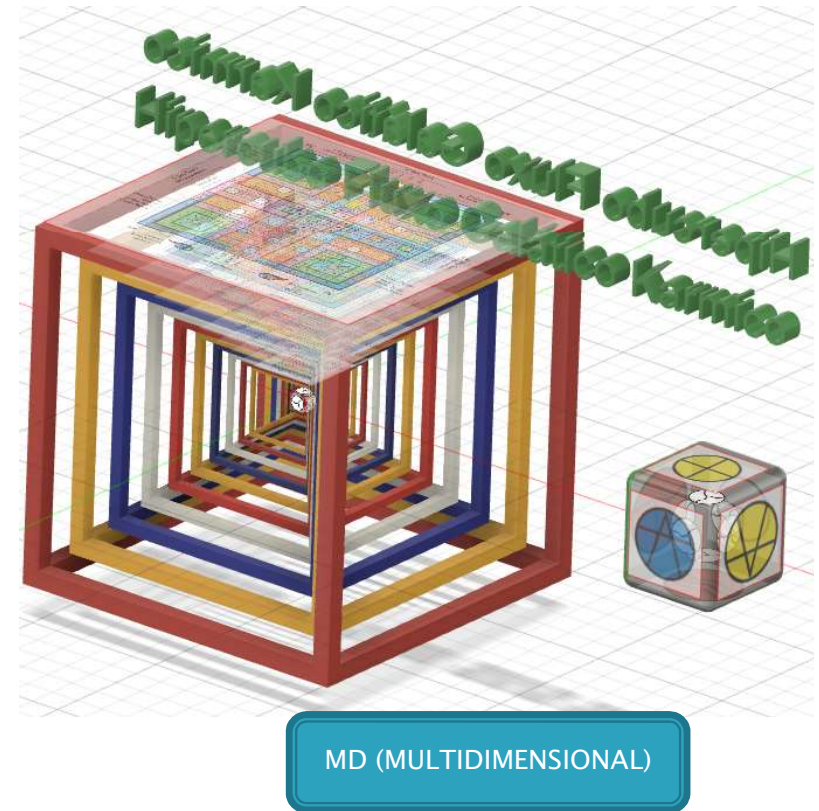
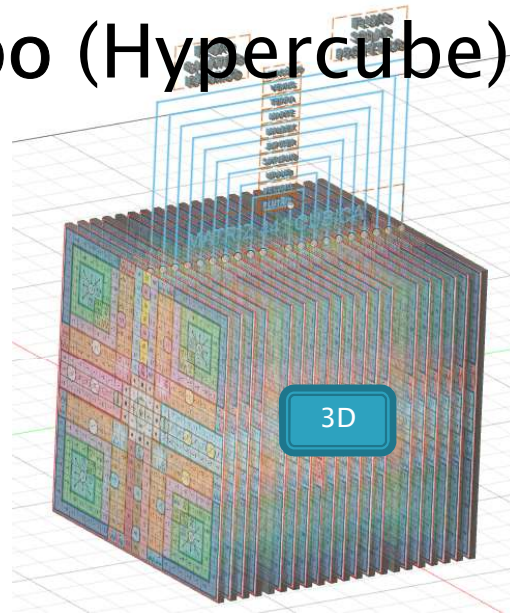
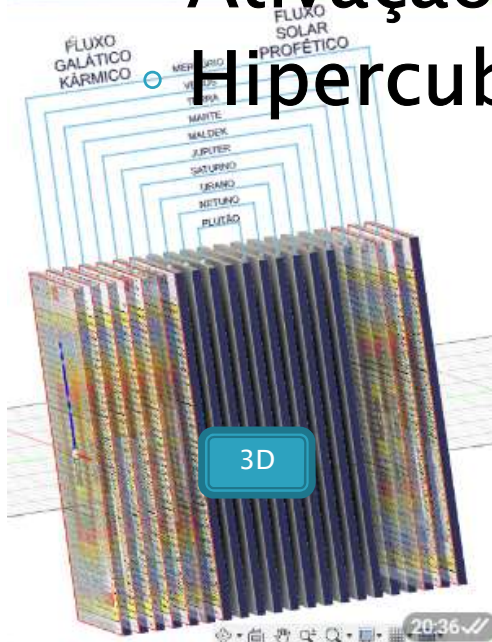

Matriz Base (UMBs)

	V1	V2	V3	V4	V5	V6	V7	V8	V9	V10	V11	V12	V13	V14	V15	V16	V17	V18	V19	V20	V21	
H1	41	40	39	38	37	36	35	34	33	32	31	30	29	28	27	26	25	24	23	22	21	
H2	42	117	116	115	114	113	112	111	110	109	108	107	106	105	104	103	102	101	100	99	20	
H3	43	118	185	184	183	182	181	180	179	178	177	176	175	174	173	172	171	170	169	98	19	
H4	44	119	186	245	244	243	242	241	240	239	238	237	236	235	234	233	232	231	168	97	18	
H5	45	120	187	246	297	296	295	294	293	292	291	290	289	288	287	286	285	284	167	96	17	
H6	46	121	188	247	298	341	340	339	338	337	336	335	334	333	332	331	330	283	166	95	16	
H7	47	122	189	248	299	342	377	376	375	374	373	372	371	370	369	368	367	366	282	165	94	15
H8	48	123	190	249	300	343	378	405	404	403	402	401	400	399	398	397	396	395	281	164	93	14
H9	49	124	191	250	301	344	379	406	425	424	423	422	421	398	367	328	281	226	163	92	13	
H10	50	125	192	251	302	345	380	407	426	437	436	435	420	397	366	327	280	225	162	91	12	
H11	51	126	193	252	303	346	381	408	427	438	441	434	419	396	365	326	279	224	161	90	11	
H12	52	127	194	253	304	347	382	409	428	439	440	433	418	395	364	325	278	223	160	89	10	
H13	53	128	195	254	305	348	383	410	429	440	431	432	417	394	363	324	277	222	159	88	9	
H14	54	129	196	255	306	349	384	411	412	413	414	415	416	393	362	323	276	221	158	87	8	
H15	55	130	197	256	307	350	385	386	387	388	389	390	391	392	361	322	275	220	157	86	7	
H16	56	131	198	257	308	351	352	353	354	355	356	357	358	359	360	321	274	219	156	85	6	
H17	57	132	199	258	309	310	311	312	313	314	315	316	317	318	319	320	273	218	155	84	5	
H18	58	133	200	259	260	261	262	263	264	265	266	267	268	269	270	271	272	217	154	83	4	
H19	59	134	201	202	203	204	205	206	207	208	209	210	211	212	213	214	215	216	153	82	3	
H20	60	135	136	137	138	139	140	141	142	143	144	145	146	147	148	149	150	151	152	81	2	
H21	61	62	63	64	65	66	67	68	69	70	71	72	73	74	75	76	77	78	79	80	1	1

2D

2D

Matriz cúbica + Hipercubo

▶ Ativação Matriz Cúbica 3D (Matrix Activation 3D)

- Matriz Base (Base Matrix)
- Matriz 441 (Matrix 441)

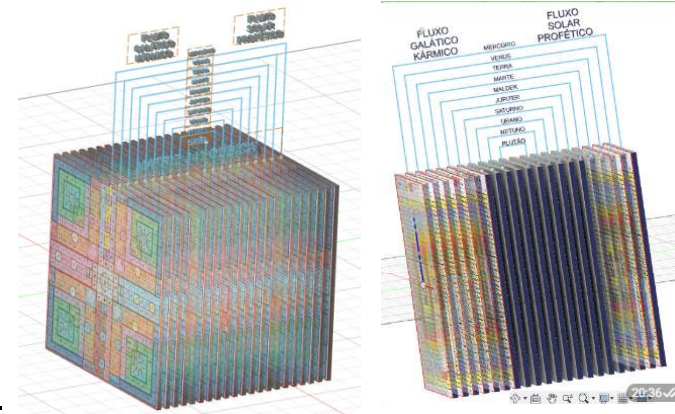

▶ Hipercubo (Hypercube)

- Dinâmica do Hipercubo (Dynamics of the Hypercube)

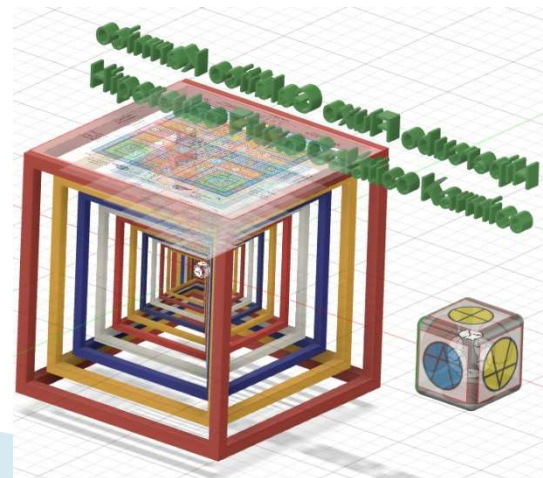

Ativação Matriz Cúbica 3D (Activation Cube Matrix 3D)



1.2.1 = 441

1.3.3.1 = 9.261

Matriz Base (UMBs)

	V1	V2	V3	V4	V5	V6	V7	V8	V9	V10	V11	V12	V13	V14	V15	V16	V17	V18	V19	V20	V21
H1	41	40	39	38	37	36	35	34	33	32	31	30	29	28	27	26	25	24	23	22	21
H2	42	117	116	115	114	113	112	111	110	109	108	107	106	105	104	103	102	101	100	99	98
H3	43	118	185	184	183	182	181	180	179	178	177	176	175	174	173	172	171	170	169	168	167
H4	44	119	186	245	244	243	242	241	240	239	238	237	236	235	234	233	232	231	230	229	228
H5	45	120	187	246	297	296	295	294	293	292	291	290	289	288	287	286	285	284	283	282	281
H6	46	121	188	247	298	341	340	339	338	337	336	335	334	333	332	331	330	329	328	327	326
H7	47	122	189	248	299	342	377	376	375	374	373	372	371	370	369	368	367	366	365	364	363
H8	48	123	190	249	300	343	378	405	404	403	402	401	400	399	398	397	396	395	394	393	392
H9	49	124	191	250	301	344	379	406	425	424	423	422	421	398	367	328	281	226	163	92	13
H10	50	125	192	251	302	345	380	407	426	437	436	435	420	397	366	327	280	225	162	91	12
H11	51	126	193	252	303	346	381	408	427	438	441	434	419	396	365	326	279	224	161	90	11
H12	52	127	194	253	304	347	382	409	428	439	440	433	418	395	364	325	278	223	160	89	10
H13	53	128	195	254	305	348	383	410	429	440	431	432	417	394	363	324	277	222	159	88	9
H14	54	129	196	255	306	349	384	411	430	441	413	414	415	416	393	362	323	276	221	158	87
H15	55	130	197	256	307	350	385	386	387	388	389	390	391	392	361	322	275	220	157	86	7
H16	56	131	198	257	308	351	352	353	354	355	356	357	358	359	360	321	274	219	156	85	6
H17	57	132	199	258	309	310	311	312	313	314	315	316	317	318	319	320	273	218	155	84	5
H18	58	133	200	259	260	261	262	263	264	265	266	267	268	269	270	271	272	217	154	83	4
H19	59	134	201	202	203	204	205	206	207	208	209	210	211	212	213	214	215	216	153	82	3
H20	60	135	136	137	138	139	140	141	142	143	144	145	146	147	148	149	150	151	152	81	2
H21	61	62	63	64	65	66	67	68	69	70	71	72	73	74	75	76	77	78	79	80	1

Matriz Base 2D

1.2.1 = 441



- circuítus planetários
- plutão
- netuno
- urano
- saturno
- júpiter
- maldek
- marte
- terra
- venus
- mercúrio

Matriz Base Cúbica (3D)

1.3.3.1 = 9.261

Planeta	Planet	
Mercúrio	MERCURY	DOG
Venus	VENUS	MONMKEY
Terra	EARTH	HUMAN
Marte	MARS	SKYWALKER
Maldek	MALDEK	WIZARD
Jupiter	JUPITERT	EAGLE
Saturno	SATURN	WARRIOR
Urano	URANUS	EARTH
Netuno	NEPTUNE	MIRROR
Plutão	PLUTO	STORM

	Planeta	Planet
MOON	Mercúrio	MERCURY
STAR	Venus	VENUS
HAND	Terra	EARTH
WORLDBRIDGER	Marte	MARS
SERPENT	Maldek	MALDEK
SEED	Jupiter	JUPITERT
NIGHT	Saturno	SATURN
WIND	Urano	URANUS
DRAGON	Netuno	NEPTUNE
SUN	Plutão	PLUTO

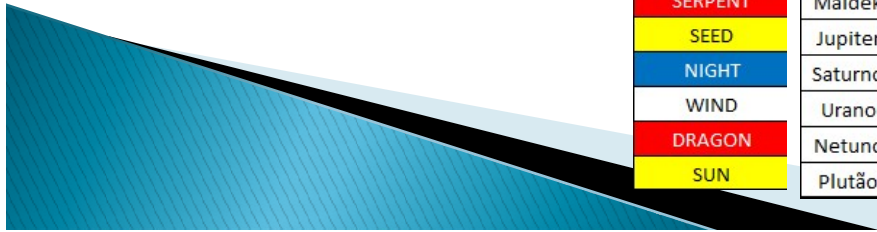

Ativação 2D-3D-MD (Activation 2D-3D-MD)

Matriz Base (UMBs)

	V1	V2	V3	V4	V5	V6	V7	V8	V9	V10	V11	V12	V13	V14	V15	V16	V17	V18	V19	V20	V21
H1	41	40	39	38	37	36	35	34	33	32	31	30	29	28	27	26	25	24	23	22	21
H2	42	117	116	115	114	113	112	111	110	109	108	107	106	105	104	103	102	101	100	99	20
H3	43	118	185	184	183	182	181									172	171	170	169	98	19
H4	44	119	186	245	244	243	242									233	232	231	168	97	18
H5	45	120	187	246	297	296	295									286	285	230	167	96	17
H6	46	121	188	247	298	341	340									331	284	229	166	95	16
H7	47	122	189	248	299	342	377									380	283	228	165	94	15
H8	48	123	190	249	300	343	378									429	282	227	164	93	14
H9	49	124	191	250	301	344	379	406	425	424	423	422	421	398	367	328	281	226	163	92	13
H10	50	125	192	251	302	345	380	407	426	437	436	435	420	397	366	327	280	225	162	91	12
H11	51	126	193	252	303	346	381	408	427	438	441	434	419	396	365	326	279	224	161	90	11
H12	52	127	194	253	304	347	382	409	428	439	440	433	418	395	364	325	278	223	160	89	10
H13	53	128	195	254	305	348	383	410	429	430	431	432	417	394	363	324	277	222	159	88	9
H14	54	129	196	255	306	349	384	411	412	413	414	415	416	393	362	323	276	221	158	87	8
H15	55	130	197	256	307	350	385	386	387	388	389	390	391	392	361	322	275	220	157	86	7
H16	56	131	198	257	308	351	352	353	354	355	356	357	358	359	360	321	274	219	156	85	6
H17	57	132	199	258	309	310	311	312	313	314	315	316	317	318	319	320	273	218	155	84	5
H18	58	133	200	259	260	261	262	263	264	265	266	267	268	269	270	271	272	217	154	83	4
H19	59	134	201	202	203	204	205	206	207	208	209	210	211	212	213	214	215	216	153	82	3
H20	60	135	136	137	138	139	140	141	142	143	144	145	146	147	148	149	150	151	152	81	2
H21	61	62	63	64	65	66	67	68	69	70	71	72	73	74	75	76	77	78	79	80	1

2D

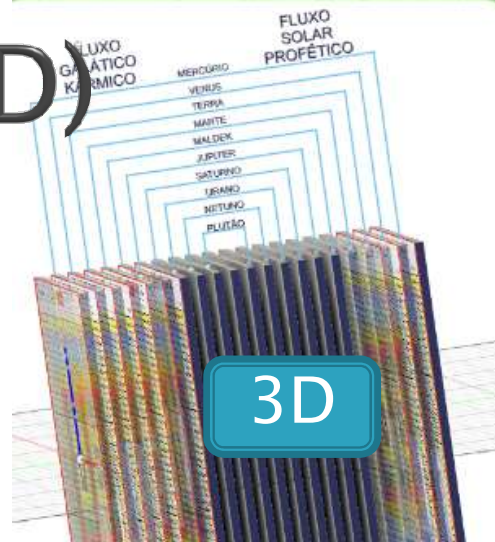

3D

1.2.1 = 441



1.3.3.1 = 9.261

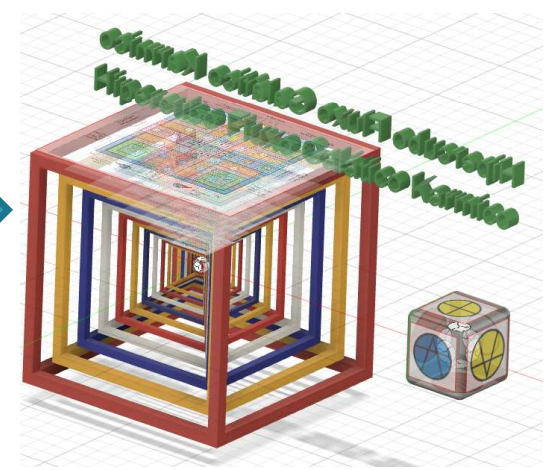
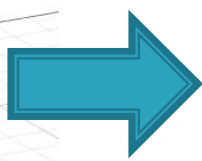

MD
(MULTIDIMENSIONAL)

7	-8	-9	-10	-11	-12	-13	14	15	16	17	18	19	20	21	22	23	24	25	26	27	28
+6	7	-8	-9	-10	-11	-12	-13	-14	-15	-16	-17	-18	-19	-20	-21	-22	-23	-24	-25	-26	-27
+5	+6	7	-8	-9	-10	-11	-12	-13	-14	-15	-16	-17	-18	-19	-20	-21	-22	-23	-24	-25	-26
+4	+5	+6	7	-8	-9	-10	-11	-12	-13	-14	-15	-16	-17	-18	-19	-20	-21	-22	-23	-24	-25
+3	+4	+5	+6	7	-8	-9	-10	-11	-12	-13	-14	-15	-16	-17	-18	-19	-20	-21	-22	-23	-24
+2	+3	+4	+5	+6	7	-8	-9	-10	-11	-12	-13	-14	-15	-16	-17	-18	-19	-20	-21	-22	-23
+1	+2	+3	+4	+5	+6	7	-8	-9	-10	-11	-12	-13	-14	-15	-16	-17	-18	-19	-20	-21	-22
0	+1	+2	+3	+4	+5	+6	7	-8	-9	-10	-11	-12	-13	-14	-15	-16	-17	-18	-19	-20	-21
-1	0	+1	+2	+3	+4	+5	+6	7	-8	-9	-10	-11	-12	-13	-14	-15	-16	-17	-18	-19	-20
-2	-1	0	+1	+2	+3	+4	+5	+6	7	-8	-9	-10	-11	-12	-13	-14	-15	-16	-17	-18	-19
-3	-2	-1	0	+1	+2	+3	+4	+5	+6	7	-8	-9	-10	-11	-12	-13	-14	-15	-16	-17	-18
-4	-3	-2	-1	0	+1	+2	+3	+4	+5	+6	7	-8	-9	-10	-11	-12	-13	-14	-15	-16	-17
-5	-4	-3	-2	-1	0	+1	+2	+3	+4	+5	+6	7	-8	-9	-10	-11	-12	-13	-14	-15	-16
-6	-5	-4	-3	-2	-1	0	+1	+2	+3	+4	+5	+6	7	-8	-9	-10	-11	-12	-13	-14	-15
-7	-6	-5	-4	-3	-2	-1	0	+1	+2	+3	+4	+5	+6	7	-8	-9	-10	-11	-12	-13	-14
-8	-7	-6	-5	-4	-3	-2	-1	0	+1	+2	+3	+4	+5	+6	7	-8	-9	-10	-11	-12	-13

2D

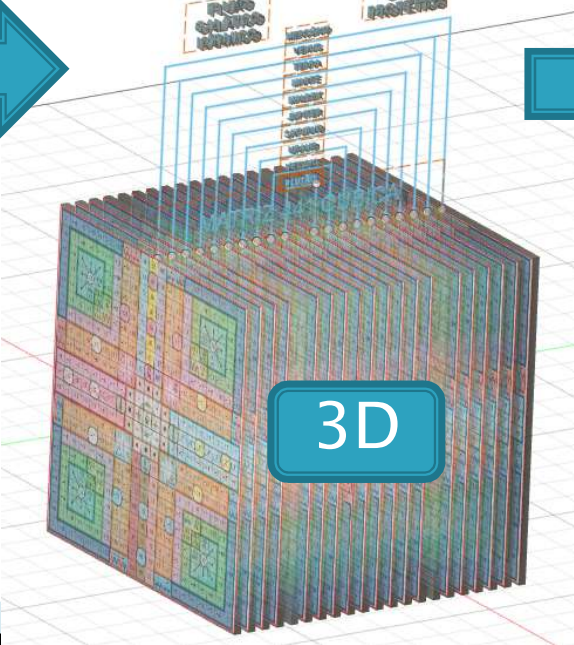

3D

Ativação Matriz Cúbica 3D (Activation Cube 3D)



1.2.1 = 441

1.3.3.1 = 9.261

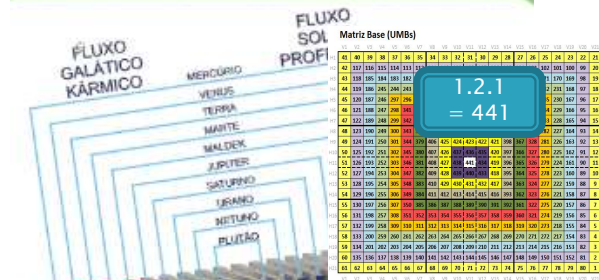

Matriz Base Cúbica (3D)

1.3.3.1 = 9.261

Matriz 441 Cúbica (3D)

MATRIZ BASE Cúbico (21*21*21 = 9.261 = 1.3.3.1)

			Planeta	Planet	Fluxo	circuito
1-441	CURADORA - MERCÚRIO (GK)	MOON	Mercúrio	MERCURY	GK	1
442-882	ARTISTA - VÊNUS (GK)	STAR	Vênus	VENUS	GK	2
883-1323	AVATAR - TERRA (GK)	HAND	Terra	EARTH	GK	3
1324-1764	HIEROFANTE - MARTE (GK)	WORLDBRIDGER	Marte	MARS	GK	4
1765-2205	INICIADO SERPENTE - MALDEK (GK)	SERPENT	Maldek	MALDEK	GK	5
2206-2646	INOCENTE - JÚPITER (GK)	SEED	Júpiter	JUPITERT	GK	6
2647-3087	SONHADOR - SATURNO (GK)	NIGHT	Saturno	SATURN	GK	7
3088-3528	SUMA SACERDOTISA - URANO (GK)	WIND	Urano	URANUS	GK	8
3529-3969	FORÇA PRIMORDIAL - NETUNO (GK)	DRAGON	Netuno	NEPTUNE	GK	9
3970-4410	ILUMINADO - PLUTÃO (GK)	SUN	Plutão			10
8821-9261	Mago do Infinito					11
3970-4410	TRANSFORMADOR DE MUNDOS - PLUTÃO (SP)	STORM	Plutão	PLUTO	SP	10
3529-3969	YOGUE / YOGUINE - NETUNO (SP)	MIRROR	Netuno	NEPTUNE	SP	9
3088-3528	NAVEGADOR - URANO (SP)	EARTH	Urano	URANUS	SP	8
2647-3087	DESCOBRIDOR DE CAMINHOS - SATURNO (SP)	WARRIOR	Saturno	SATURN	SP	7
2206-2646	VIDENTE - JÚPITER (SP)	EAGLE	Júpiter	JUPITERT	SP	6
1765-2205	MAGO - MALDEK (SP)	WIZARD	Maldek	MALDEK	SP	5
1324-1764	PROFETA - MARTE (SP)	SKYWALKER	Marte	MARS	SP	4
883-1323	SÁBIO - TERRA (SP)	HUMAN	Terra	EARTH	SP	3
442-882	ILUSIONISTA - VÊNUS (SP)	MONMKEY	Vênus	VENUS	SP	2
1-441	COMPASSIVO - MERCÚRIO (SP)	DOG	Mercúrio	MERCURY	SP	1

1.3.3.1 = 9.261

Ativação Matriz Cúbica 3D (Activation Cube 3D)

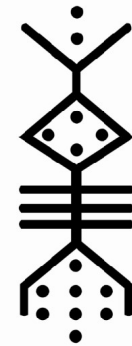
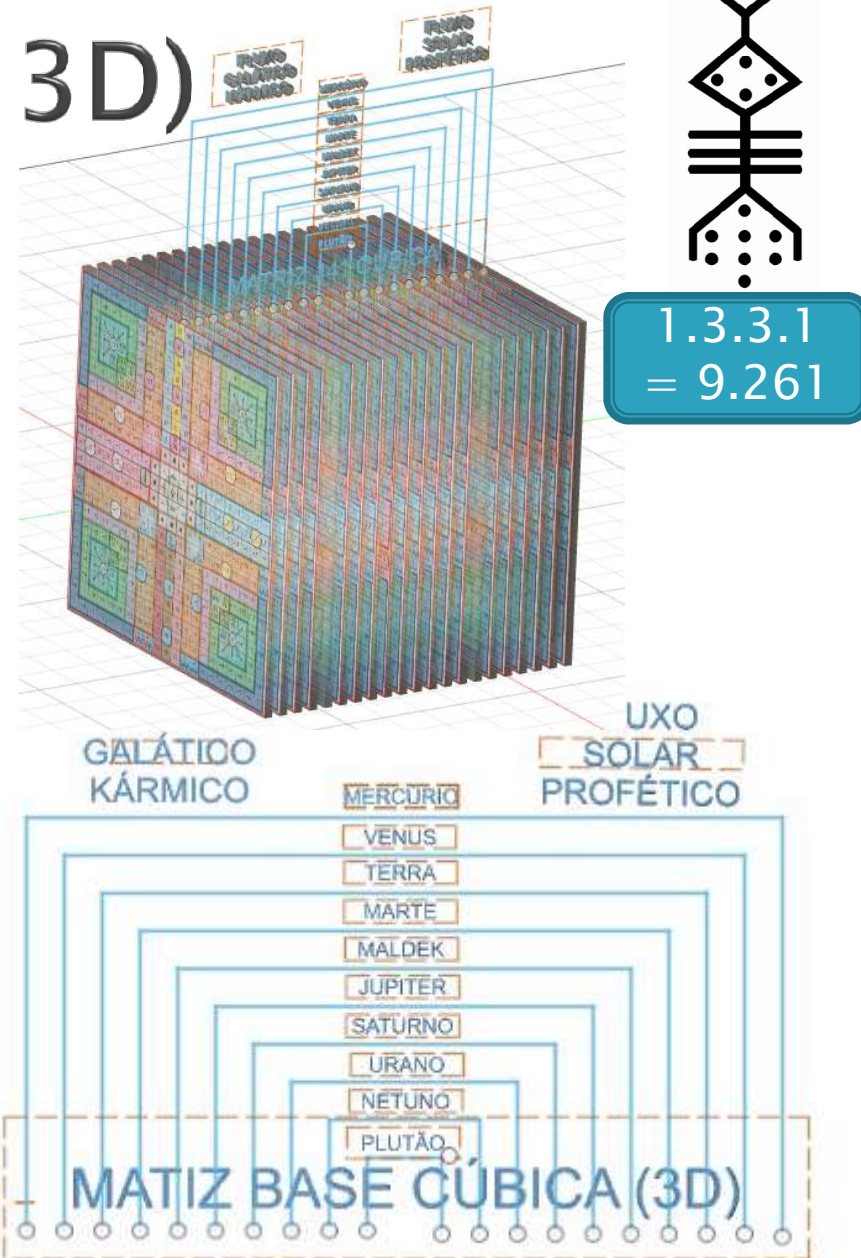
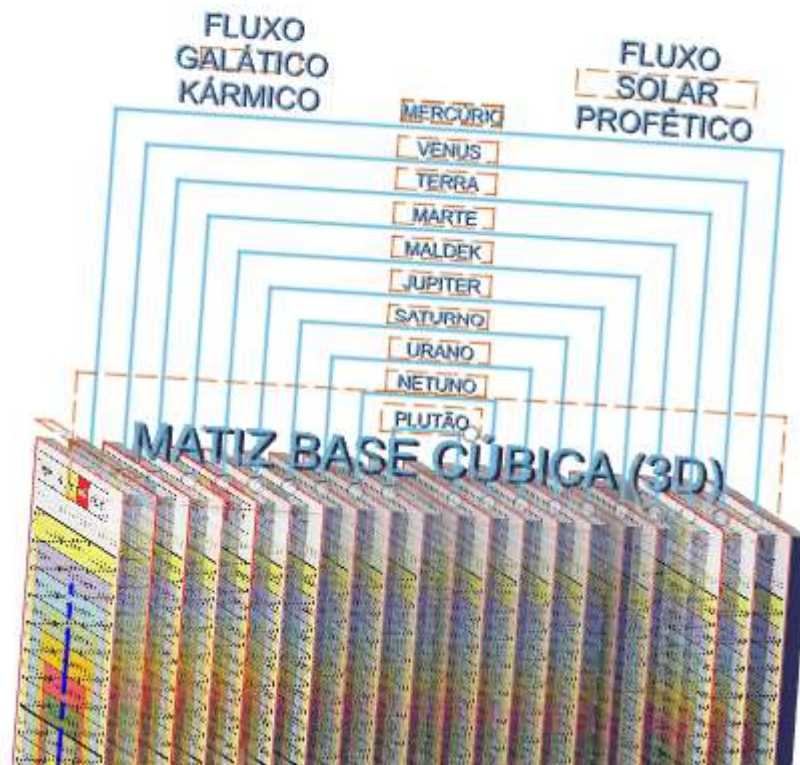

1.3.3.1
= 9.261

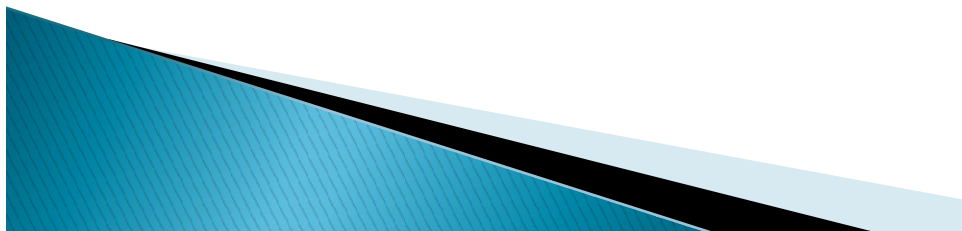

Ativação 2D→3D (Activation 2D→3D)

animação: <https://youtu.be/1HzSfugC9dl>

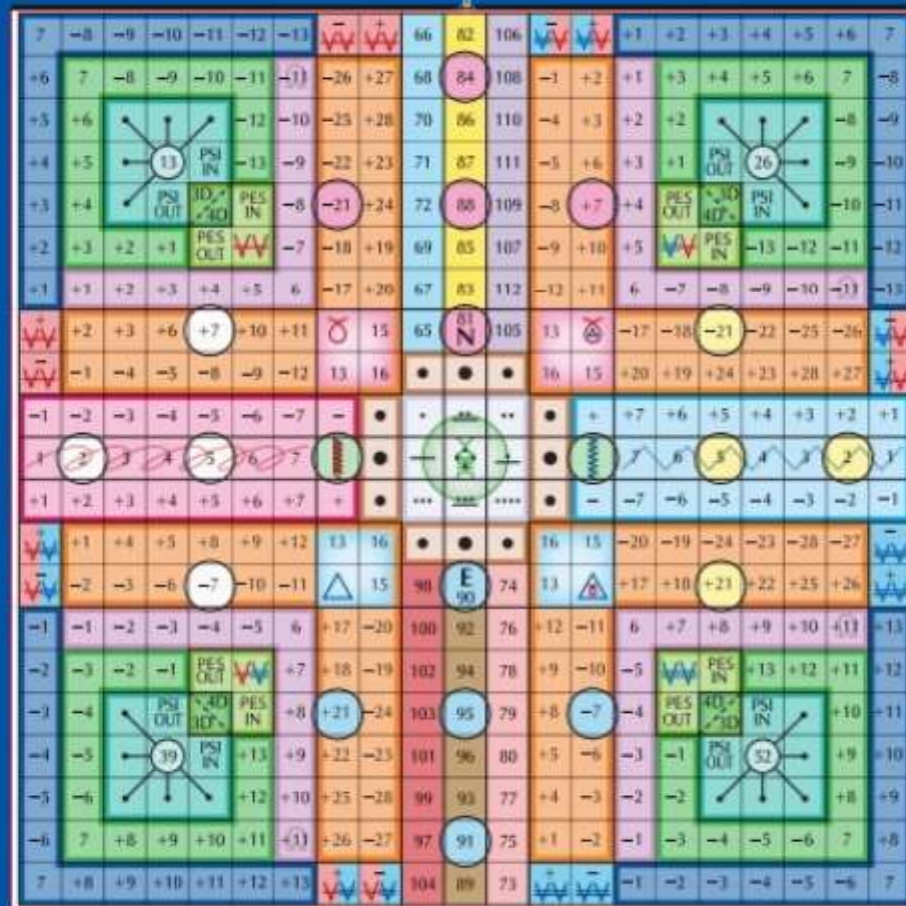

Dinamica Hiper cubo (Dynamics Hypercube)

- ▶ Alternância através dos Plasmas (Galáctico Karmico)

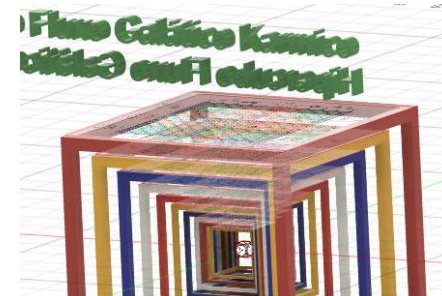

Dinamica Hiper cubo
(Dynamics Hypercube)

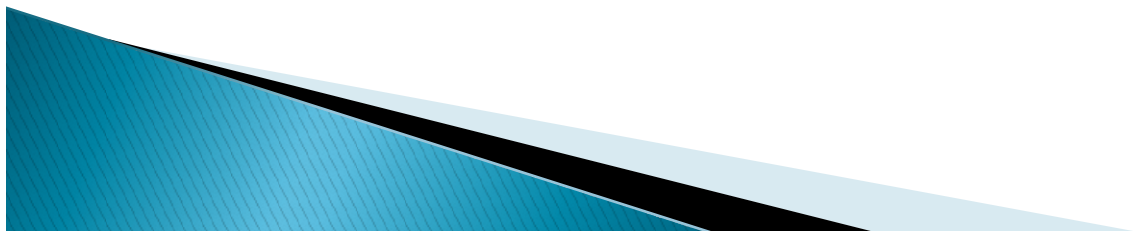
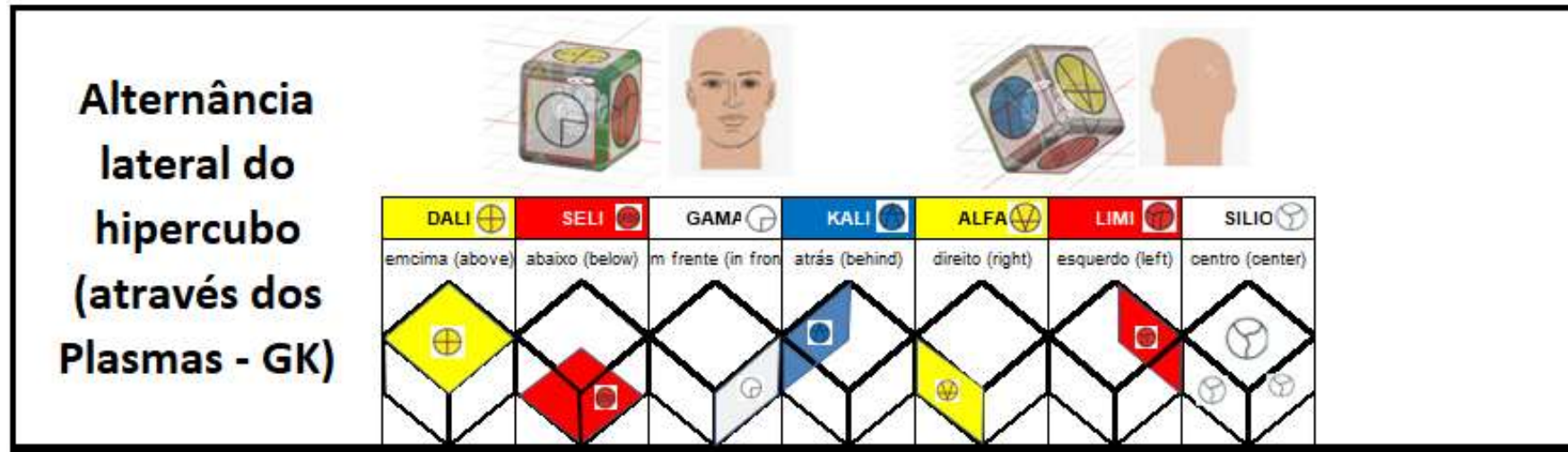

Hipercubo Fluxo Galático Kármico (GK)

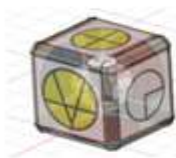

DALI - acima (above) (GK)



KALI - atrás (behind) (GK)



LIMI - esquerdo (left) (GK)

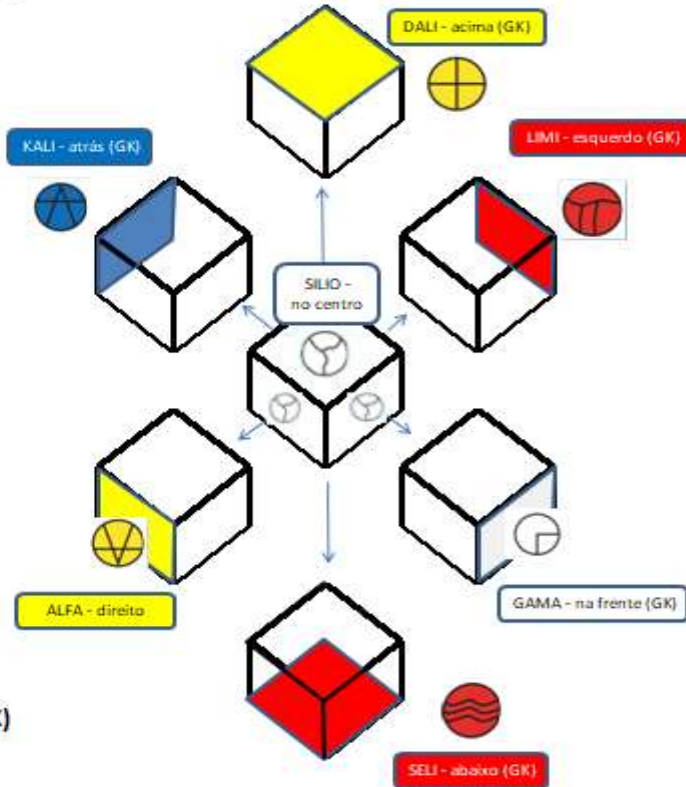

ALFA - direito (right) (GK)



GAMA - na frente (in front) (GK)



SELI - abaixo (below) (GK)

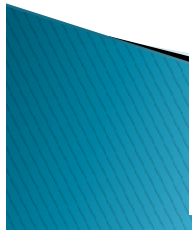
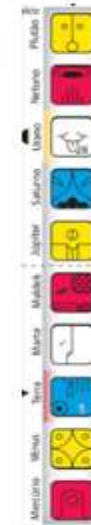

Dinamica Hiper cubo (Dynamics Hypercube)



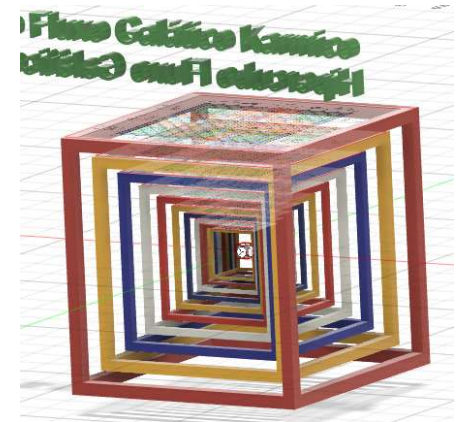















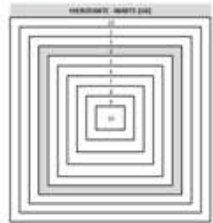
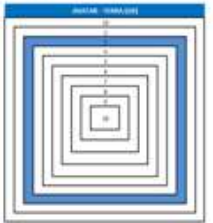

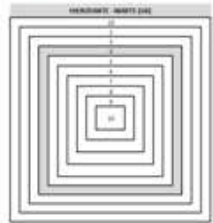
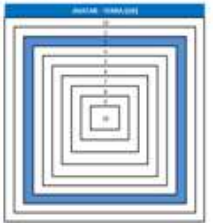
- ▶ Alternância de circuito do hiper cubo através dos arquétipos (Galáctico Karmico)



arquétipo		circuito (circuit) 10 GK	circuito (circuit) 9 GK	centro (center)
ILUMINADO - PLUTÃO (GK)	GK			
FORÇA PRIMORDIAL - NETUNO (GK)	GK			
SUMA SACERDOTISA - URANO (GK)	GK			
SONHADOR - SATURNO (GK)	GK			

Dinamica Hipercubo (Dynamics Hypercube)

- ▶ Alternância de circuito do hipercubo através dos arquétipos (Galáctico Karmico)

arquétipo		circuito (circuit) 6 GK	circuito (circuit) 5GK		
INOCENTE - JUPITER (GK)	GK				
INICIADO SERPENTE - MALDEK (GK)	GK				
arquétipo		circuito (circuit) 4 GK	circuito (circuit) 3 GK		
HIEROFANTE - MARTE (GK)	GK				
AVATAR - TERRA (GK)	GK				
arquétipo		circuito (circuit) 2 GK	circuito (circuit) 1 GK	externo (extern)	
ARTISTA - VENUS (GK)	GK				
CURADEIRA - MERCÚRIO (GK)	GK				



Dinamica Hiper cubo (Dynamics Hypercube)

- ▶ Alternância através dos Plasmas (Solar Profético)

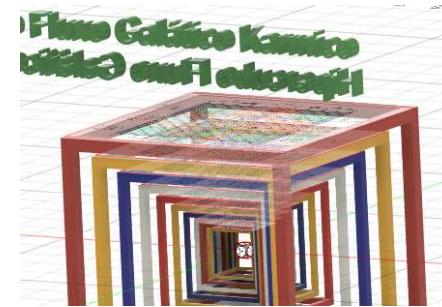

Dinamica Hiper cubo
(Dynamics Hypercube)

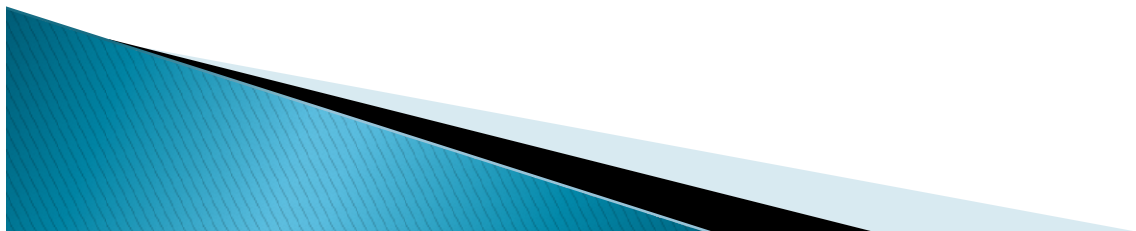
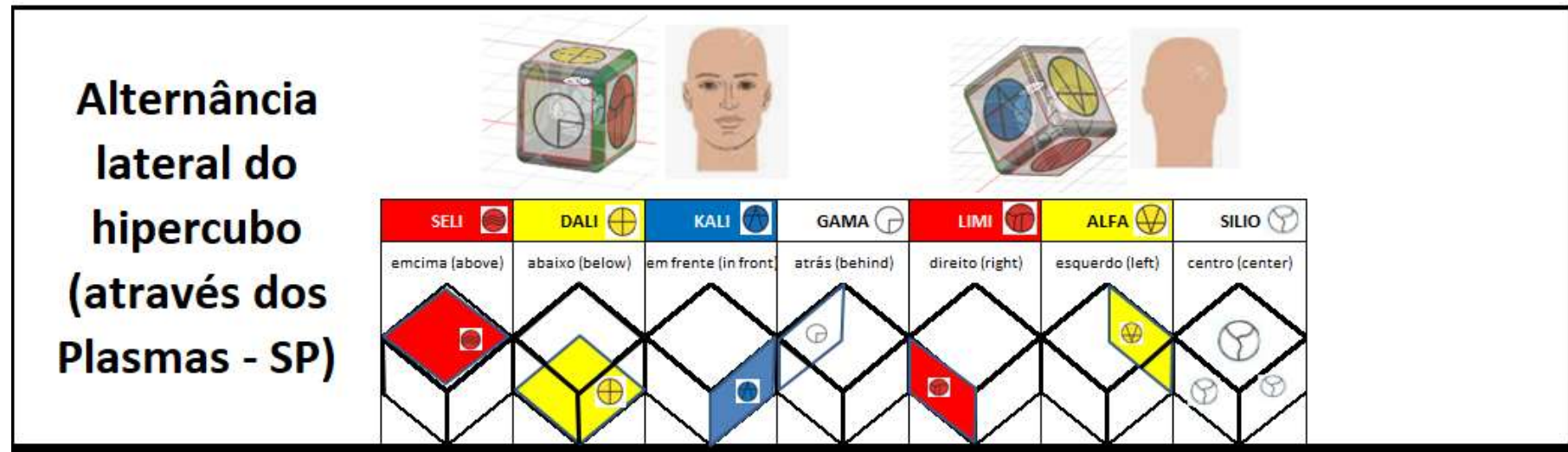

Hipercubo Fluxo Solar Profético (SP)

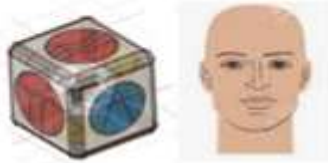

SELI - acima (above) (SP)

GAMA - atrás (behind) (SP)



ALFA - esquerdo (left) (SP)

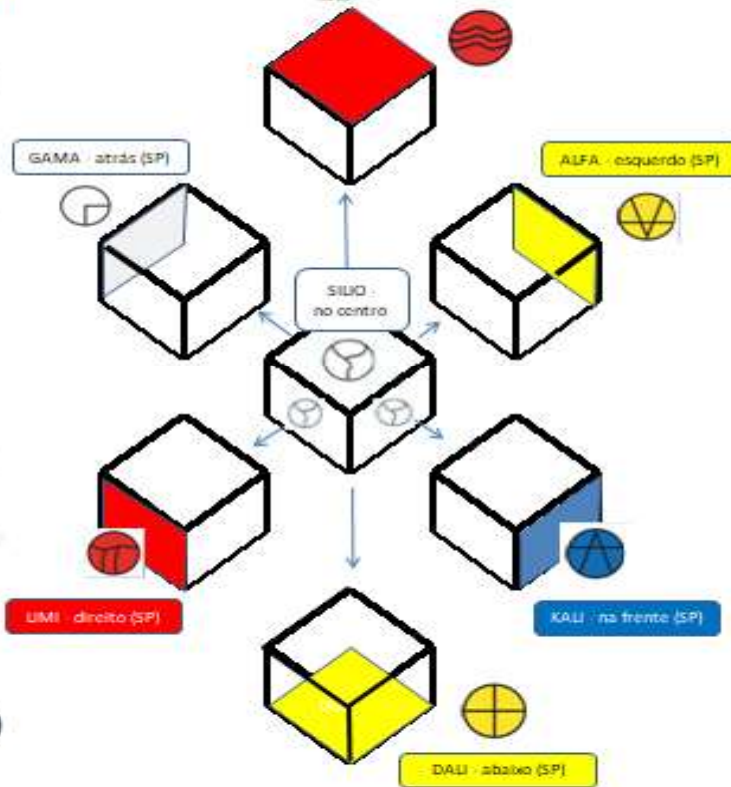

LIMI - direito (right) (SP)



KALI - na frente (in front) (SP)



DALI - abaixo (below) (SP)

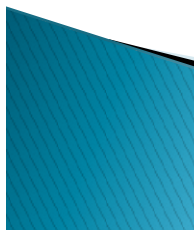

Dinamica Hipercubo (Dynamics Hypercube)

- ▶ Alternância de circuito do hipercubo através dos arquétipos (Solar Profético)

arquétipo	CIRCUÍTO		circuito (circuit) 10 SP	circuito (circuit) 9 SP
TRANSFORMADOR DE MUNDOS - PLUTÃO (SP)	10	SP		
YOGUE/YOGUINE - NETUNO (SP)	9	SP		
arquétipo			circuito (circuit) 8 SP	circuito (circuit) 7 SP
NAVEGADOR - URANO (SP)	8	SP		
DESCOBRIDOR DE CAMINHOS - SATURNO (SP)	7	SP		

Dinamica Hipercubo (Dynamics Hypercube)

- ▶ Alternância de circuito do hipercubo através dos arquétipos (Solar Profético)

arquétipo			circuito (circuit) 6 SP	circuito (circuit) 5 SP
VIDENTE - JUPITER (SP)	6	SP		
MAGO - MALDEK (SP)	5	SP		
arquétipo			circuito (circuit) 4 SP	circuito (circuit) 3 SP
PROFETA - MARTE (SP)	4	SP		
SÁBIO - TERRA (SP)	3	SP		
arquétipo			circuito (circuit) 2 SP	circuito (circuit) 1 SP
ILUSIONISTA - VENUS (SP)	2	SP		
COMPASSIVO - MERCÚRIO (SP)	1	SP		

Dinamica Hiper cubo (Dynamics Hypercube) animação: <https://youtu.be/vsBHBI0Lcrc>

